



CITY OF WILDOMAR SINGLE FAMILY RESIDENTIAL DESIGN STANDARDS & GUIDELINES



Adopted: January 13, 2004 (Riverside County)

Revised: November 14, 2018 (Wildomar City Council)



CITY OF WILDOMAR

**ORIGINALLY ADOPTED BY RIVERSIDE COUNTY BOARD OF
SUPERVISORS ON JANUARY 13, 2004**

**AND AS AMENDED
BY THE**

CITY OF WILDOMAR CITY COUNCIL ON NOVEMBER 14, 2018

Based upon the original Board action (and subsequent Wildomar City Council action as amended), these Standards and Guidelines are **not** applicable to those residential subdivisions described within, that as of January 13, 2004, had completed the environmental process, with the related environmental document done and the subdivision set for public hearing. The Standards and Guidelines are applicable to all other residential subdivisions described within.

TABLE OF CONTENTS

I.	<u>INTRODUCTION</u>	1
	A. Design Strategies	2
	B. Planning Objectives	2
	C. Applicability	3
	D. Exceptions.....	3
II.	<u>RESIDENTIAL</u>	4
	A. Design Style	4
	B. Articulation of Building Facades	5
	C. Varied Roof Planes	6
	D. 360 Degree Architecture.....	6
	E. Streetscape Design	8
	1. Varied Building Heights/Rooflines - Minimum Number of Single Story Units	8
	2. Multiple Floor Plans and Elevations	8
	3. Variable Front Yard Setbacks	9
	4. Colors and Materials.....	9
	F. Garage Location and Design.....	10
	G. Walls and Fencing.....	11
	H. Lighting	13
	I. General Site Plan Requirements	13
	J. Mailbox Design.....	14
	K. Residential Design Features.....	14
	L. Residential Lot Design.....	15
	1. Schedule of Design Standards.....	15
	2. Minimum Lot size.....	16
	3. Maximum Lot Coverage.....	16
	4. Minimum Spacing Between Structures	16
	5. Minimum Net Usable Area	17
	M. Watercourses and Drainage	17
	N. Recreational Vehicle Parking.....	18

III. <u>RESIDENTIAL STREET DESIGN</u>	19
A. Street Pattern: Curvilinear and Grid Street Design	19
B. Street Width Reductions	19
C. Minimum Street, Median, Reverse Frontage, and Parkway Widths	20
D. Bus and Transit - Related Facilities	20
IV. <u>LANDSCAPE DESIGN STANDARDS</u>	21
A. Neighborhood Entry Statements	21
B. Corner Cutbacks or Cutoffs	22
C. Landscaped Medians	22
D. Reverse Frontage Treatments	22
E. Yard Landscaping Requirements	24

List of Exhibits

APPENDIX A

- Exhibit A: Meandering Sidewalk
- Exhibit B: Entry Monument and Landscaping
- Exhibit C: Entry Median Landscaping and Concrete Stamping
- Exhibit D: Landscaped Berms
- Exhibit E: Reverse Frontage Treatments
- Exhibit F: General Local Street
- Exhibit G: Collector Streets
- Exhibit H: Secondary Highway
- Exhibit I: Major Highway
- Exhibit J: Commercial Arterial Highway
- Exhibit K: Residential Arterial Highway
- Exhibit L: Commercial (Urban) Arterial Highway
- Exhibit M: Residential (Urban) Arterial Highway
- Exhibit N: Interior Vinyl Fencing for Tract Developments – Fence Detail
- Exhibit O: Interior Vinyl Fencing for Tract Developments – Site Diagram

APPENDIX B

- Additional Photographic Examples
- Building Articulation
- Front Porch Treatments
- Landscape Buffers, Mini-Parks, and Paseos
- Walls and Fences
- Garage Door Treatments

City of Wildomar Single Family Residential Design Standards & Guidelines

I. INTRODUCTION

“The physical character of our communities cannot be divorced from the values they respect. Sooner or later, these values manifest themselves in how our development decisions are made and how those decisions shape our communities. Where our values and actions are synchronized, our communities prosper; where they are in conflict, so are the communities. (Riverside County Integrated Plan (RCIP), 2002)”

Riverside County like a quilt, is a composite of differing lifestyles connected together through common strands. The RCIP and subsequent General Plan are designed to ensure that the quilt retains its core identity by guiding future growth that respects the diversity of the region, shapes and configures development in relation to the land it occupies and ensures that its various parts relate to its whole. This unity of form also promotes innovative development that actively accommodates a balance of housing, employment, and service opportunities for the citizenry.

These Design Standards and Guidelines (hereinafter “Guidelines”) are for the use of those property owners and design professionals submitting development applications to the City of Wildomar Planning Department. The following design guidelines and standards were originally developed by the County of Riverside (now being implemented by the City of Wildomar) with assistance of representatives from several of the municipalities in the County. In addition, it is intended that this document will provide the baseline criteria, in which to measure and to evaluate justifications for potential density bonuses under the RCIP Incentives Program.

This document includes both design “standards” and design “guidelines.” Design standards are considered mandatory requirements and usually include the term “shall.” Standards are often quantitative or have performance criteria that can be measured. Design guidelines are more generalized statements, alternatives, or illustrations of what is expected and encouraged. In this sense, the “guidelines” may offer ways to meet a certain “standard.” The degree to which the design guidelines are met is subject to a finding or determination made by the City.

Note: Variations to either the design standards or guidelines may be considered and approved by the Planning Commission and/or City Council in the review of any single family residential tract project.

A. Design Strategies

To successfully shape the City's future, piecemeal regulations must be replaced by overall strategies, guidelines, and standards that maintain base values and promote connectivity. Design strategies have been developed to provide for the continuous evolution of urban and rural form consistent with the sense of knowing where one is, the enjoyment in moving through urban/rural environments and providing the opportunity to experience physical and visual variety and diversity throughout the City. Enhancing community edges, landmarks, districts, nodes, and paths can strengthen the physical and visual experiences creating this composite image of the City of Wildomar. Design strategies include:

- Recognizing each community in the City as an identifiable and unique place.
- Defining corridors that, on the one hand link communities, but on the other create distinctive edges that separate and protect each community's qualities and character.
- Promoting interesting juxtapositions that contrast boundaries between distinctly different characteristics of existing neighborhoods.
- Identifying and protecting commonly used view points, view paths, natural panoramas and views of major community landmarks.
- Protecting, repairing, restoring and interconnecting natural watercourses and associated riparian habitat which serve as a unifying element.
- Planning and designing streets and thoroughfares which are visually integrated into the landscape by promoting a distinct sense of district, neighborhood and place.
- Preserving natural and built landmarks which create a special or unique community flavor.
- Protecting and preserving buildings, structures and established public places which are historically and culturally significant.
- Planning and designing new neighborhoods in ways that make them visually distinctive / identifiable and please the senses.

In an attempt to advance quality and visually distinctive development responsive to the natural and built environment of the City of Wildomar, the Board of Supervisors has adopted these Residential Design Standards & Guidelines. These standards and guidelines have been crafted to assist those individuals submitting development applications to better understand the design context from which the City will evaluate project submittals.

The Planning Commission or City Council may consider variations to the design standards as part of their hearing process. Staff may modify design guidelines during the project review process if alternatives meet the intent or context of the adopted guidelines. However, changes to the guidelines will be noted as part of a staff report to the Hearing Officer, Planning Commission, or City Council.

B. Planning Objectives

Based on the Design Strategies outlined in the RCIP and Riverside County General Plan, it is the City's desire to advance several specific development goals including:

- Ensure that new homes are constructed in neighborhoods that are interesting and varied in appearance.
- Utilizing building materials and enhanced landscaping to promote a look of quality, both at the time of initial occupancy, as well as in future years.

- Encouraging efficient use of land while creating high quality communities that will maintain their economic values and long-term desirability as places to live and work.
- Incorporating conveniently located and accessible neighborhood parks, trails, and open space.
- Providing functional public access to recreational opportunities in relation to the overall open space system.

C. Applicability

Provisions of the City of Wildomar Residential Design Standards & Guidelines supplement the minimum specifications for land development in the Wildomar Municipal Code (Title 16 & 17), and will be incorporated by reference in all applicable development Conditions of Approval. The Standards & Guidelines pertain to the following types of projects located within the City:

- The “Residential Standards” in this document are required for any residential subdivision with a minimum lot size of one-half (1/2) acre or less, and located in the following residential zoning districts: R-R, R-A, R-1, R-1A, R-2, R-2A, R-3, R-3A, R-4 and R-6.
- Where a residential lot is smaller than 7,200 square feet, the Standards & Guidelines related to unit location, setbacks, percent (%) of lot coverage and street frontage may be waived if the project applicant demonstrates that they have addressed the Planning Objectives in Section B above, as well as, providing a sense of privacy and personal space for each residential unit.
- The Residential Design Standards & Guidelines will be evaluated for effectiveness and revised as appropriate in conjunction with any future comprehensive update to the Wildomar General Plan and Zoning Ordinance.

D. Exceptions

The City of Wildomar Design Standards & Guidelines shall apply to all applicable development projects unless:

- Other standards have been imposed upon an individual development project by the Planning Commission and/or the City Council.
- Other standards have been adopted by the City Council relative to a particular designated area of a District (e.g., Community Plans / Specific Plans).
- Physical constraints of an individual site make the application of a particular standard or guideline impractical.

Commercial Design Standards & Guidelines

Design Standards & Guidelines for Commercial development is currently being drafted and will be published in separate documents.

II. RESIDENTIAL

A. Design Style

A design style or a common palette of architectural features is encouraged for each neighborhood or community usually through a planned development, Specific Plan or the Incentive Program. A design style is not required; however, consistency in the design features and use of materials is encouraged.



Craftsman Style

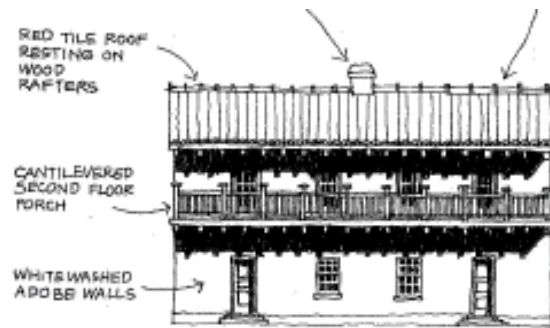

Monterrey Style



Queen Anne Style

B. Articulation of Building Facades

Long unarticulated building facades shall be avoided by incorporating varying setbacks of the building footprint in a varied fashion along the residential street. Projecting architectural features such as bowed or bay windows, columns, offset roof planes, and similar features should be used to create both vertical and horizontal articulation on the building elevations. These design elements shall also be included on the rear facades and sides of homes that are adjacent to or visible from streets or open spaces. Houses shall be arranged in a manner that creates a harmonious, varied appearance of building heights and setbacks.

Special design features, such as covered front porches, garage placement to rear of a lot, use of multiple floor plans, window and door articulation, extended overhangs and building edge treatments (such as arbors, awnings or trellises) are encouraged. Windows should be framed with compatible materials to create well-defined “edge” treatments and be designed to provide distinctive shadows on the building facades. These design features may be accomplished in a manner similar to the following photographic examples.



Recessed windows



Entry Features, porch and setback garage



Front Porch with Offsetting Planes



Bow or Bay Windows

C. Varied Roof Planes

Roof articulation may be achieved by changes in plane or by the use of traditional roof forms such as gables, hips, and dormers. A-frame type roofs and mansard roofs are discouraged unless part of a coordinated design theme style.



Flat Roof/Contemporary Style



Multiple Gables



Varied Roof Forms



D. 360 Degree Architecture

Architectural design treatments such as building offsets, recessed windows, trellises, overhangs, or other features shall occur on those facades of the residence that are visible from streets or open spaces.



E. Streetscape Design

1. Varied Building Heights/Rooflines - Minimum Number of Single Story Units

Houses and garages shall be arranged in a manner that creates a harmonious, varied appearance of building heights. All projects of ten (10) or more residential lots shall include at least one single-story floor plan. In any residential tract development, single-story homes should be located on the perimeter of the tract development visible from public streets, and on corner lots whenever possible. Regardless of the number of lots, 10% of the homes in each tract development shall be single-story homes to maintain a rural design character.



2. Multiple Floor Plans and Elevations

Floor Plans. At a minimum, there should be three (3) different floor plans for tract maps with 50 or less units. Reverse floor plans are not included as different floor plan. For tract maps with from 51 to 99 units, there shall be at least four (4) different floor plans. Tract maps with 100 units or more shall provide five (5) different floor plans and an additional floor plan for every 100 dwelling units above 100 units.

For development projects that are to be constructed in phases, a phasing plan shall be submitted to assure that the requirements for the number of floor plans is being met.

Elevations. Each floor plan shall have at least three (3) distinct elevations. One (1) elevation shall not be repeated more than each fourth house. Please note that adding or deleting false shutters, or similar types of minimal elevation changes will not suffice as one of the required distinct elevations.

3. Variable Front Yard Setbacks

Homes and garages shall be placed at varying distances from the street and have varying entry locations. Front yard setbacks shall average 20 feet, and may be varied by up to 25%, in increments of any size. The minimum front yard setback shall not be less than 15 feet.

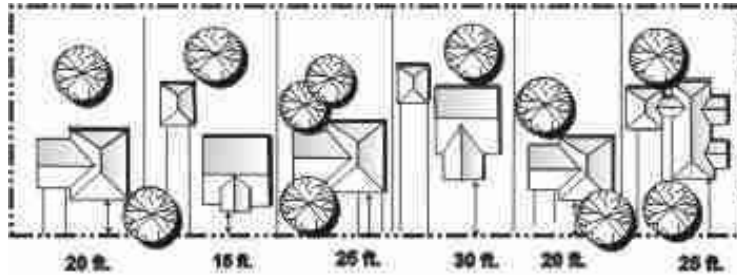

4. Colors and Materials

The colors and materials on adjacent residential structures should be varied to establish a separate identity for the dwellings. A variety of colors and textures of building materials is encouraged, while maintaining overall design continuity in the neighborhood. Color sample boards shall be submitted as a part of the application and review process.



F. Garage Location and Design

The visual impact of garages should be reduced by the use of additional setback from the curb face where garage doors must face the street or by the use of side-facing or rear garages (including detached garages) where possible. Residential plans that feature attached garage designs whose entries are from the side (“side-loaded garages”) are also encouraged. Where more than two (2) garage doors face the street, the third garage door should have an increased setback or offset.

Setbacks for the side-loaded garages shall be consistent with those specified in Title 17 (Zoning Ordinance). Garage access from an alley is also encouraged. All new residences with garages shall be provided with roll-up (i.e. on tracks) garage doors (either sectional wood or steel). At least 25% of the garage doors in any project should have windows. Building and lot layouts shall conform to residential zoning standards regarding minimum garage setbacks from access streets, minimum yard requirements, and maximum height. Detached garages located at the rear of the property, and “drive through” or “tandem” garages are also encouraged.

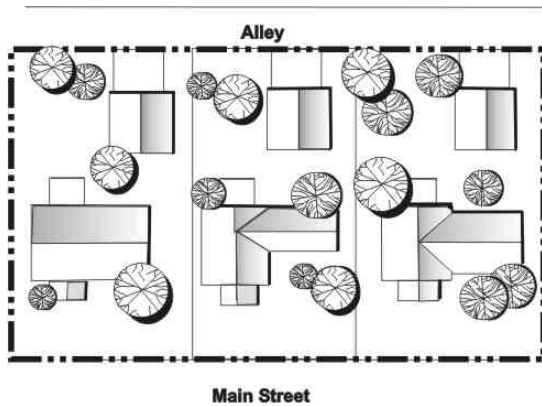

Garages with Alley Access



Side-Facing Garage Door



Offset Garage Doors



Decorated Garage Doors with Windows

G. Walls and Fencing

Walls and Fencing shall be designed in accordance with the following standards:

1. Front yard return walls shall be constructed of decorative masonry (i.e., slump stone, split-face or material of similar appearance, maintenance, and structural durability) and shall be a minimum of five (5) feet in height. The maximum height of front yard return walls shall not exceed six (6) feet in height.
2. Side yard gates are required on one side of front yard, and shall be constructed of wrought iron, wood, vinyl, or tubular steel. Side and rear yard fencing shall be masonry, slump stone or other material of similar appearance, maintenance, and structural durability. Chain link fencing is not permitted. All construction must be of good quality and sufficient durability with an approved stain and/or sealant to minimize water staining. (Applicants shall provide specifications that shall be approved by the Planning Department).



3. All new residences constructed on lots of less than 20,000 square feet shall include rear and side yard fencing constructed of decorative masonry block (i.e., slump stone, split-face or material of similar appearance, maintenance, and structural durability) that is a minimum of five (5) feet in height, and not exceed six (6) feet in height.
 - a. Vinyl fencing may be used as an alternative to decorative block for interior side and rear property lines provided they are not visible from the public street (see Exhibit O).
 - b. If vinyl fencing is used, it shall be constructed of commercial grade quality, have aluminum posts, have an aluminum rail on the bottom of the panel to prevent sagging, and shall meet at least a 101 mph wind speed requirement (see Exhibit N).
4. In the event of an elevation change between two (2) lots that would cause the side yard fencing to be elevated two (2) or more feet above the lower lot return wall, the first 5-feet of the interior side yard fencing shall be of the same type of wall as the return wall, after which vinyl fencing may be used.
5. All lots having rear and/or side yards facing local streets or otherwise open to public view shall have fences or walls constructed of decorative block (i.e., slump stone, split-face, stucco etc.).
6. All Corner lots shall be constructed with wrap-around decorative block wall returns (i.e., slump stone, split-face, etc.).
7. Side yard gates are required on one side of the home and shall be constructed of powder-coated wrought iron or tubular steel.
8. Wrought iron or tubular steel fence sections may be included within tracts where view opportunities and/or terrain warrant its use. Where privacy of views is not an issue, tubular steel or wrought iron sections should be constructed in perimeter walls in order to take advantage of casual view opportunities.
9. Wrought iron, tubular steel, wood, vinyl, or chain link fences, or gates are allowed where a residence is being constructed on a lot of at least 20,000 square feet.
10. Wood fencing, where permitted, shall be constructed with galvanized steel posts set in concrete to a minimum depth of 24 inches with domed caps. Wood fencing or other like-material walls are not permitted along reverse frontage areas.
11. Perimeter walls for tract developments shall be constructed of decorative block (i.e., slump stone, split-face, brick or stucco) where view opportunities are not available. Plain concrete masonry block walls are not permitted to be used for perimeter walls (i.e., cinder-block). The use of ivy or other vegetative material to soften and punctuate the appearance of perimeter walls and reduce the likelihood of graffiti is strongly encouraged. The use of pilasters and capping in conjunction with other vertical design elements to temper the top line of the perimeter wall is also highly encouraged.
 - a. In the event that circumstances occur that a perimeter wall becomes effectively an interior side or interior rear wall to residential lots, at the discretion of the Planning

Department, vinyl fencing may be substituted for the wall as long as no portion of the vinyl fencing is visible to the public.

12. Swimming pool fencing shall meet all City safety provisions of the California Building Code. Fences around swimming pools shall have an outside surface free of provisions, cavities, or other physical characteristics that would serve as handholds or footholds that could enable a child below the age of five to climb.

H. Lighting

All outdoor lighting within a single family residential projects shall be designed and constructed in accordance with the provisions and regulations of Chapter 8.64 (Light Pollution, Ordinance No. 75) of the Wildomar Municipal Code, and be low to the ground or shielded and hooded to avoid shining onto adjacent properties and streets. Street lighting standards are addressed by other City Ordinances. Illuminated street address lighting fixtures shall be installed on the front yard side of each dwelling to facilitate location of the street address numbers for safety and public convenience and to compensate for dark sky lighting considerations. "Dark Sky's" provisions such as lower lighting levels, backlit addresses and street signs, and other indirect lighting methods shall be required.

I. General Site Plan Requirements

Building and lot layouts shall conform to the City of Wildomar standards regarding minimum garage setbacks from access streets, minimum yard requirements, maximum height requirements, and other county standards, unless specific variances are granted. The following information shall be submitted with the building permit applications and as a part of the Final Site Plan of Development (FSPOD) review process.

1. Building footprints for each lot which identify the model number of the home shall be included on the tract map.
2. Front, rear, and side elevations of all facades of all models to be constructed within the tract shall be included on separate sheets.
3. Front, rear, and side yard setbacks of all homes shall be shown on the tract map.
4. Typical landscape plans for each model (including all plant names/varieties and container sizes).
5. Landscape plans for reverse frontages and neighborhood entry statements and medians (including all plant names/varieties and container sizes).
6. Material and color sample boards shall be provided.

J. Mailbox Design

Installation of cast iron, cast aluminum, brick, or slump stone-encased curbside mailboxes are encouraged. Each mailbox installation shall conform to current United States Postal Service standards.



K. Residential Design Features

1. All new residences should have at least one clean-burning fireplace, unless otherwise prohibited by state fire codes.
2. Provision for solar heating/cooling equipment or other energy conservation or saving equipment is encouraged. As required in Title 16 (Subdivisions), subdivision layout and design shall address future passive or natural heating and cooling opportunities. Attention to the extreme heat conditions in the summer shall be viewed as a significant element in project review. Homes and buildings should be oriented to receive the greatest amount of afternoon shade or other protection from the sun. Lot size and configuration should consider future orientation of a structure to take advantage of shade and prevailing winds.

L. Residential Lot Design

All "Schedule A" residential tract maps within the City of Wildomar shall be designed consistent with the following design standards.

1. Schedule of Design Standards

Description	For lots 7200 square feet or greater	For lots less than 7200 square feet
Minimum net usable area (See section L (5) below)	6,500 sq. ft.	Not less than 85% of total area
Minimum lot widths (frontage) Variation of lot width is encouraged	65 ft. An average of seventy (70 feet) or wider of road frontage, as measured at the property line. (The average excludes lots fronting on cul-de-sacs or street knuckles)	50 ft. A minimum of fifty (50) percent of the lots within each tract should have fifty-five (55) feet or wider of road frontage, as measured at the property line.
Lot width at frontage on cul-de-sac lots or street knuckle ¹	The minimum lot frontage on a knuckle or a cul-de-sac shall be 40 feet measured along the property line unless otherwise specified in the development standards of the zoning classification.	The minimum lot frontage on a knuckle or a cul-de-sac shall be 40 feet measured along the property line unless otherwise specified in the development standards of the zoning classification.
Minimum front yard setback for side-loaded	15 ft.	10 ft.
Recommended minimum depth of rear yards	20 ft.	15 ft.
Spacing between Structures ³	10 ft.	10 ft.

Notes to Schedule of Design Standards

1. The For purposes of satisfying the minimum frontage requirement, corner lots with angle cuts shall be measured at their rear property line.
2. Planned Residential Development or Specific Plan or the Incentives Program provisions allow for smaller setbacks on a case by case basis, with minimum spacing determined by UBC requirements.
3. Yard encroachments permitted under Ordinance No. 348 may interrupt this spacing. However, on lots less than 7,200 square feet, such encroachment into the side yard may occur in only one side yard, and the side yard into which the gate opens must remain a minimum of five feet in width.
4. A patio and patio cover may extend into a rear yard by right up to 10 feet (no Planning permit required, only Building and Safety Department permit.) For all lots, swimming pools and swimming pool equipment may extend into the backyard, with a setback adjustment, to within five feet of the property line.

2. Minimum Lot Size

The minimum residential lot size within a Schedule “A” housing tract shall be no smaller than 7,200 square feet consistent with the R-1 zone development standards. Reductions in the lot size may be permitted only through the Variance process as approved by the Planning Commission. Projects located within a Specific Plan or Planned Residential Development or participating in the Incentives Program may have reduced lot areas based upon the quality of the design and the provision of additional open space areas, parks or other exceptional public improvements or amenities.

The lot area should not be less than 7,200 square feet for a detached single-family residential unit in the Medium Density Residential (MDR) land use designation (2 - 5 units/acre). For developments in the Medium High Density Residential (MHDR) and High Density Residential (HDR) land use designations, the minimum lot size will be determined through the discretionary review process consistent with the R-2, R-3, R-4 and R-6 zone requirements and will be based upon the types of housing products proposed, and the specific amenities to be provided.

3. Maximum Lot Coverage

No residential lot within a “Schedule A” housing tract should have a lot coverage of greater than 50% (including the garage).

4. Minimum Spacing Between Structures

Side yards should be varied to add interest and usable space, however, the minimum spacing between two structures shall be ten feet. In the case of zero lot line developments, a three (3) foot maintenance easement shall be provided.

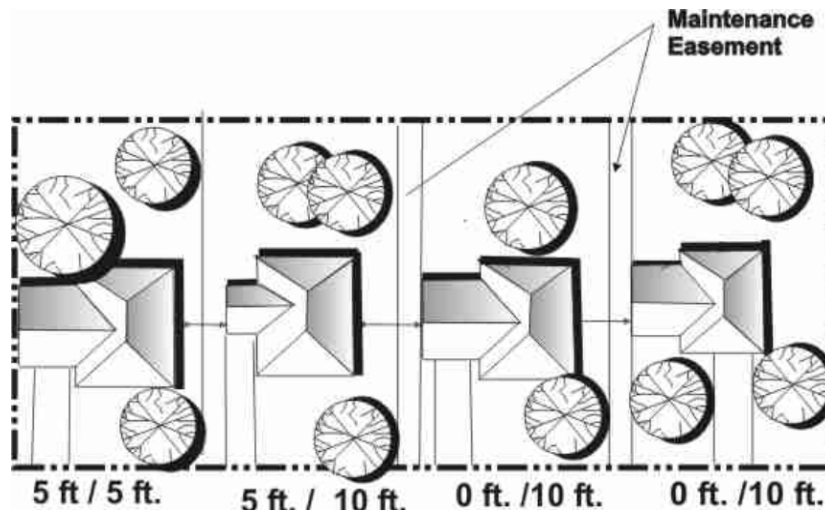

5. Minimum Net Usable Area

For projects with lots of 7,200 square feet or greater, the minimum net usable area for development should be 6,500 square foot pads or twenty foot level rear yards. Side yards shall be a minimum of five feet level on one side with no encroachments and the opposite side yard shall be a minimum of five feet with limited encroachments (three feet clear). Usable areas of less than 6500 square feet may be permitted through a specific plan, planned development application or through the Incentives Program. For lots with steep topography, the minimum net usable area shall be determined by the Planning Director based upon the site constraints analysis in order to minimize disturbance to the sloped areas. The site design should minimize cut and fill as much as possible.



Minimum Level Building Area

M. Watercourses and Drainage

The planning and design of residential communities should protect the natural land forms watercourses and drainage patterns of the site. Consideration should be given to linear parks and enhancement of the edges along watercourses and drainage ways. Efforts should be made to protect and preserve the natural vegetation along watercourses and to re-vegetate degraded areas.

N. Recreational Vehicle Parking

1. No recreational vehicle shall be stored in the front yard, or on the driveway in the front of any residential structure.
2. The storage of boats, camper trailers, or other watercraft or non-commercial vehicle may be permitted in the side yard so long as it is located behind an opaque wall, fence, or gate. A paved parking surface is required.

III. RESIDENTIAL STREET DESIGN

Residential streets shall be designed with the goal of facilitating the desired general residential design concepts. The following elements shall be used to accomplish this goal:

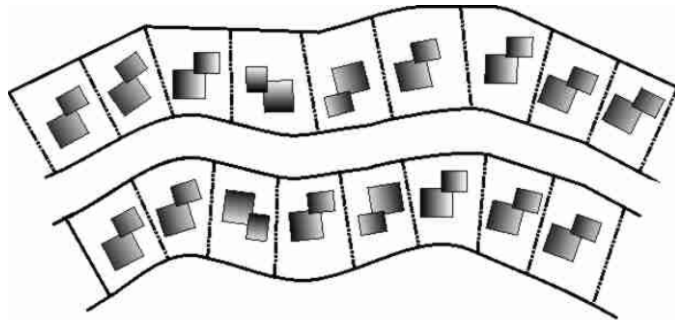

Curvilinear Streets add interest to the Streetscape

A. Street Pattern: Curvilinear and Grid Street Design

The design of the overall street pattern should present a variety of streetscapes, offer various driving and pedestrian experiences, clearly distinguish between streets of varying purposes and carrying capacities and ensure safe, walkable local neighborhoods. Curvilinear streets offer an ever-changing scene while straight streets offer concentrated focus and landmark/vista opportunities. Either may be permissible. Grids, particularly with short, walkable blocks are encouraged as are traffic calming features associated with neighborhood streets such as chicanes, chokers or bulbs, T-intersections, diverters and round-a-bouts. To the extent possible, direct connections with adjoining properties and projects are encouraged to alleviate congestion on arterials and secondary highways. All applicants are requested to consult with Transportation and Planning Staff concerning an acceptable street design concept. Examples of acceptable designs are available upon request. Projects are encouraged to be designed with efficient street circulation patterns that provide visual interest and creativity to the subdivision design.

B. Street Width Reductions

The General Plan and ordinances provide for local roads (36-foot wide within a 56-foot right-of-way) that may serve to reduce speeds in residential areas and encourage pedestrian use, while providing for emergency vehicular access.

Within planned private communities, a further reduction in local street width may be appropriate, subject to the review and approval of the Transportation Department. In these instances, the private streets should have parking restrictions in place and enforced by a Home Owner's Association to assure that proper access for emergency vehicles is maintained at all times.

C. Minimum Street, Median, Reverse Frontage, and Parkway Widths

The following table shows the minimum street, median, and parkway widths (refer to the Exhibit indicated in the Exhibit column for illustrated sections of these requirements). These standards are adopted as a part of the General Plan and are duplicated here as a convenient reference. Separate standards may be adopted for rural and mountainous areas.

Street Type	Total Width:		Median Width	Total Minimum Parkway Width per Side	Landscaping	Side walk	Exhibit
	ROW	Curb to Curb					
Local	56'	36'	Not required	10'	5'	5'	F
Collector	74'	44'	Not required	15'	10'	5'	G
Secondary	100'	64'	Not required	18'	13'	5' ¹	H
Major	118'	76'	12' Painted	21'	16'	5' ²	I
Arterial (Commercial)	128'	86'	18'	21'	15"	6'	J
Arterial (Residential)	128'	86'	18' ³	21'	16'	5' ²	K
Urban Arterial (Commercial)	152'	110'	14'	21'	15'	6'	L
Urban Arterial (Residential)	152'	110'	14' ³	21'	16'	5' ²	M

- (1) 5' Sidewalk in middle of 18' parkway
- (2) 5' Meandering sidewalk for 21' parkways
- (3) Curbed and landscaped medians

D. Bus and Transit - Related Facilities

Bus stops, turnouts, bus shelters, and other transit facilities shall be provided in accordance with the standards established by the Riverside Transit Agency (RTA) and other applicable agencies. Residential areas planned adjacent to commercial centers shall consider convenient vehicular and pedestrian access to the centers and transit access areas.

IV. LANDSCAPE DESIGN STANDARDS

A. Neighborhood Entry Statements

Any Schedule A Subdivision with 50 lots or greater shall have entry statements that create a distinctive image of a particular residential development. This entry feature should be designed to assist passing motorists to easily identify the development, and should complement the overall appearance of the greater community of which it is a part. Exhibit “C” provides an illustrative example of an entry monument and landscaping. All intersections of General Plan roads classified as Secondary Highway or higher shall have tract entrance designations. A tract entrance designation shall consist of a neighborhood identification sign on a decorative wall or monument, with at least a twelve-foot depth of landscaping (measured from the right-of-way line) surrounding the wall or monument (Exhibit “B”). No element of the tract entrance designation shall be placed within the public right-of-way. The developer shall create private party maintenance arrangements for these elements at the time the project is built.



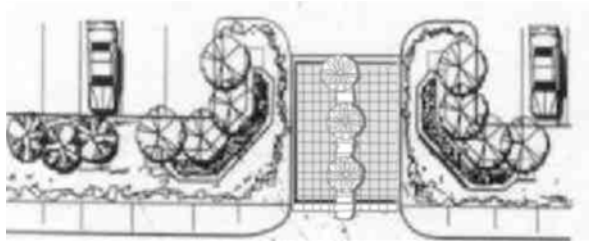

B. Corner Cutbacks or Cutoffs

Corner cutbacks or cutoffs shall be included at all intersections of General Plan roads classified as Secondary Highway or higher with all designated tract entrances. A minimum curb radius of 35 feet shall be provided at these intersections (Exhibit C).

C. Landscaped Medians

Where required, landscaped street medians shall be constructed for the following road classifications within the Districts, consistent with the following Exhibits:

Exhibit "J"	Commercial Arterial Highway
Exhibit "K"	Residential Arterial Highway
Exhibit "L"	Commercial Urban Arterial Highway
Exhibit "M"	Residential Urban Arterial Highway

Similarly, at all designated residential tract entrances from roadways classified as Secondary Highways or higher, a landscaped entry median shall be installed. Decorative trees, shrubs, and drought tolerant landscaping planted in medians should be clustered in random patterns rather than planted in evenly-spaced locations. Other acceptable median treatments include stamped concrete or river rock between landscaped areas.

D. Reverse Frontage Treatments

Where reverse frontage occurs on Schedule "A" residential streets, the following guidelines shall apply:

1. The reverse frontage is defined as the parkway and sidewalk widths combined. Wider reverse frontage treatments should be employed on General Plan roadways with eighty-eight feet of right-of-way or more or where design considerations would make them appropriate (e.g., where project amenities like bike or jogging paths are included).
2. Meandering walks should be constructed to provide a random influence to the rigid geometry of the adjoining street scene. Adequate parkway widths are required to assure that the sidewalks create unique landscaping opportunities and do not take on a cramped, arbitrary appearance. Meandering walks that are designed to make use of existing mature trees or other natural aspects, e.g., large boulders, are encouraged.

3. Meandering sidewalks are encouraged and should be incorporated at the Specific Plan Map/Tentative Tract Map stage of project development. When a meandering sidewalk is appropriate along a particular reverse frontage, it shall be constructed consistent with the standards and examples shown in Exhibit A and Exhibit E.



4. Equestrian or hiking trails and bikeways and other recreational facilities shall be integrated into such treatments wherever required by current adopted local and regional trails system plans.
5. The location of lakes, parks, and other open space assets adjacent to major roads and other community entry points is encouraged to enhance community appearance and identity.
6. Reverse frontage treatments shall be maintained by a property owners' association or other maintenance entity, approved by the City, which insures maintenance in perpetuity.
7. Community perimeter (or theme) walls shall be solid walls located where view opportunities are not available. Plain concrete block walls are not permitted along reverse frontage areas. Wood fencing or other like-material walls are not permitted along reverse frontage areas. Brick, slump stone, tile, textured concrete, or other material walls that require little or no maintenance are required. Use of ivy or other vegetative material to soften and punctuate the appearance of walls and reduce the likelihood of graffiti is strongly encouraged. The use of capping in conjunction with other vertical design elements to temper the top line of the wall is also encouraged.
8. Where privacy of views is not an issue, powder-coated tubular steel or wrought iron sections may be constructed in perimeter walls in order to take advantage of casual view opportunities. A combination of a two-foot to three-foot high solid wall base with a wrought iron or tubular steel fence section between solid pilasters is a recommended design alternative.

9. The typical maximum height of walls or fencing shall be six feet. Note that a greater height for perimeter walls may be required where noise mitigation or other special circumstances would dictate.
10. Recreational amenities should be encouraged as a part of reverse frontage treatments.
11. For a maximum effect, landscaping within the reverse frontage treatments shall be designed to have a “stepped-up” appearance, with low flowering ground cover nearest the curb, progressing to low and/or medium height plants or shrubs, and on to randomly clustered street trees near the perimeter wall of the tract. Plants shall be selected from the applicable Water District’s approved list.

E. Yard Landscaping Requirements

All new residences shall be provided with front yard landscaping and an automatic irrigation system. Drought tolerant landscape materials should be used as much as possible, especially in the desert areas. Landscaping shall be provided as follows:

1. A minimum of six, five-gallon shrubs, one 24" box tree (minimum 2" caliper), and one 15 gallon or larger tree (minimum 1" caliper) shall be planted along the front of all homes (garage and side yard gate areas are excluded).
2. Creative project design uses of hardscape, decorative gravels, placement of landscaping for afternoon shade and water efficient irrigation systems are encouraged.
3. Landscaping should also consider the often high wind conditions of many portions of the City, providing hedges and windbreaks where appropriate, such as in common areas, and the strong securing of recently planted trees.
4. Street parkways and common lots, such as retention basins, shall be provided with landscaping consisting of decorative gravels, living ground covers, shrubs, and some trees.
5. Additional street facing common landscape planters should be encouraged in subdivision design for bikeways, recreational trails, neighborhood entry statements and noise buffering.
6. An appropriate maintenance entity shall be required for landscaping installed outside of the street right-of-way.
7. Location of landscaping shall be in accordance with applicable City Ordinances and Water Efficient Landscape Guidelines.
8. Drought tolerant landscape materials shall be provided in accordance with Title 17 and the Water Efficient Landscape Guidelines.

APPENDIX A

Exhibit A: Meandering Sidewalk

Exhibit B: Entry Monument and Landscaping

Exhibit C: Entry Median Landscaping and Concrete Stamping

Exhibit D: Landscaped Berms

Exhibit E: Reverse Frontage Treatments

Exhibit F: General Local Street

Exhibit G: Collector Streets

Exhibit H: Secondary Highway

Exhibit I: Major Highway

Exhibit J: Commercial Arterial Highway

Exhibit K: Residential Arterial Highway

Exhibit L: Commercial (Urban) Arterial Highway

Exhibit M: Residential (Urban) Arterial Highway

Exhibit N: Interior Vinyl Fencing for Tract Developments – Fence Detail

Exhibit O: Interior Vinyl Fencing for Tract Developments – Site Diagram

Exhibit A

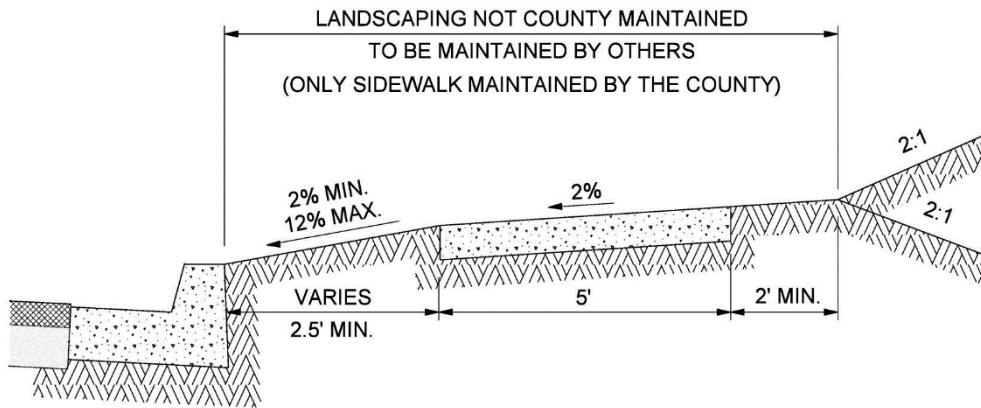
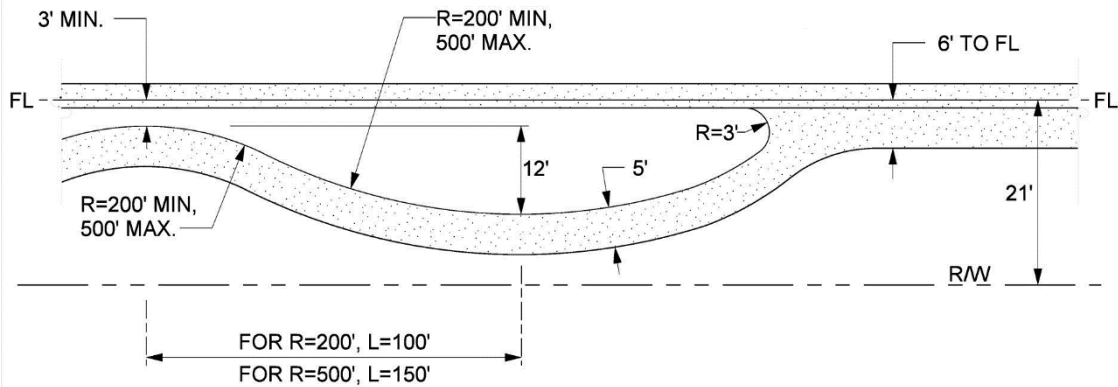

NOTES:

1. RADII FOR CURVED SIDEWALK SHALL VARY BETWEEN 200' AND 500' AT FRONT OF SIDEWALK.
2. SIDEWALK SHALL BE A MINIMUM OF 6' IN WIDTH ADJACENT TO CURB.
3. SIDEWALK SHALL BE 3' AWAY FROM CURB FACE EXCEPT AT CURB RETURNS AND BUS STOPS.
4. SIDEWALK LAYOUT ON PLANS IS CONCEPTUAL ONLY. APPROVAL OF THE FINAL SIDEWALK LAYOUT SHALL BE MADE IN THE FIELD AND ADJUSTED AS NECESSARY TO MEET FIELD CONDITIONS AS APPROVED BY THE INSPECTOR PRIOR TO FINAL CONSTRUCTION.

<h1>COUNTYWIDE DESIGN GUIDELINES</h1>	COUNTY OF RIVERSIDE
	<h2>MEANDERING SIDEWALK</h2>

1-29-04

ENTRY MONUMENT AND LANDSCAPING

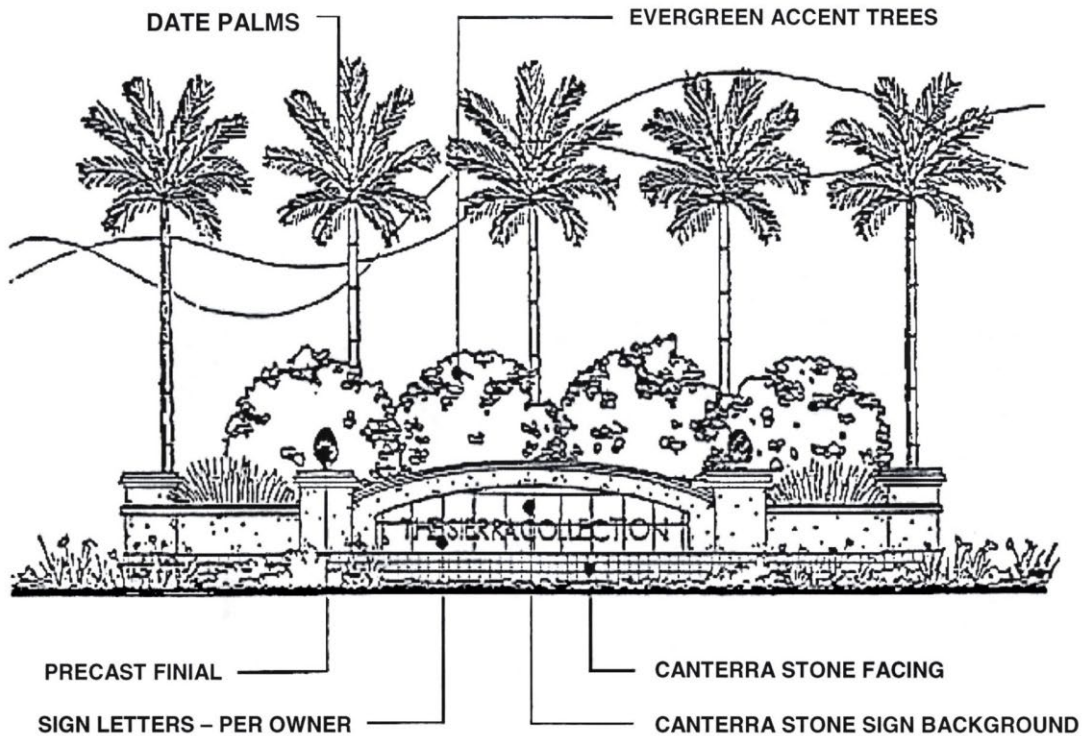

UPLIGHTING OF LANDSCAPING AND SIGN IS REQUIRED

COUNTYWIDE DESIGN GUIDELINES

COUNTY OF RIVERSIDE

**ENTRY MONUMENT
AND LANDSCAPING**

LANDSCAPED BERMS

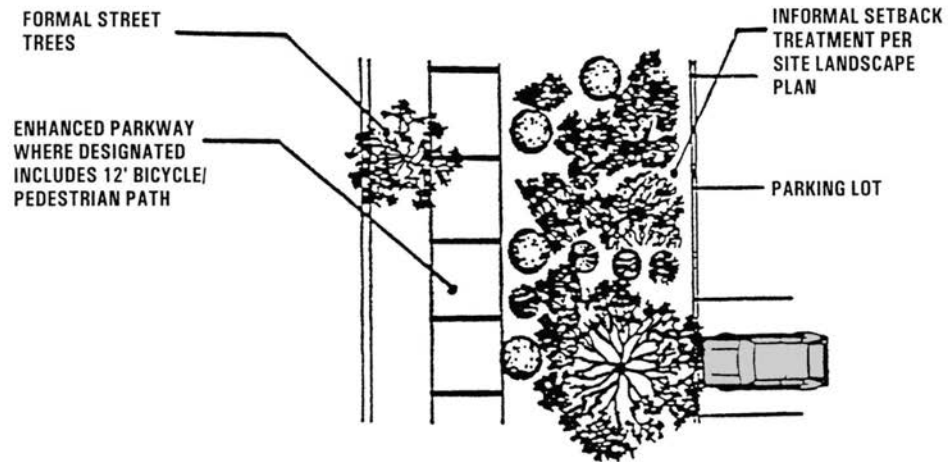
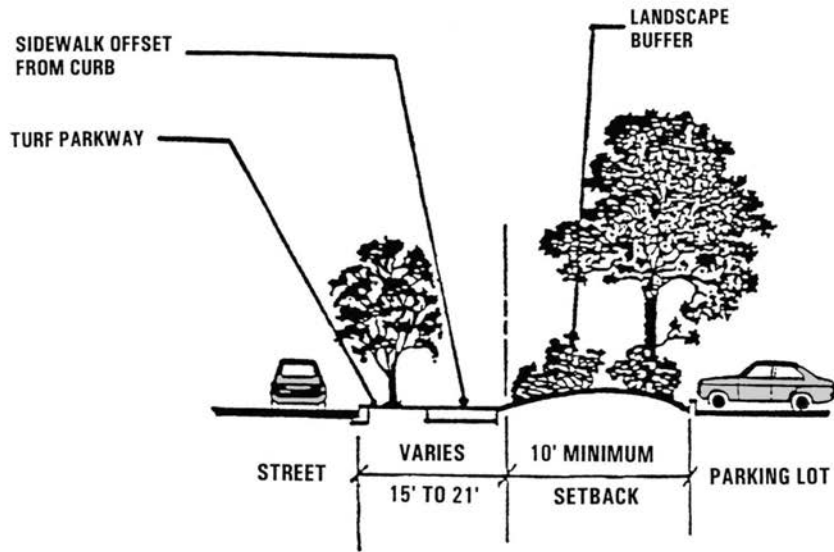

COUNTYWIDE DESIGN GUIDELINES

COUNTY OF RIVERSIDE

LANDSCAPED BERMS

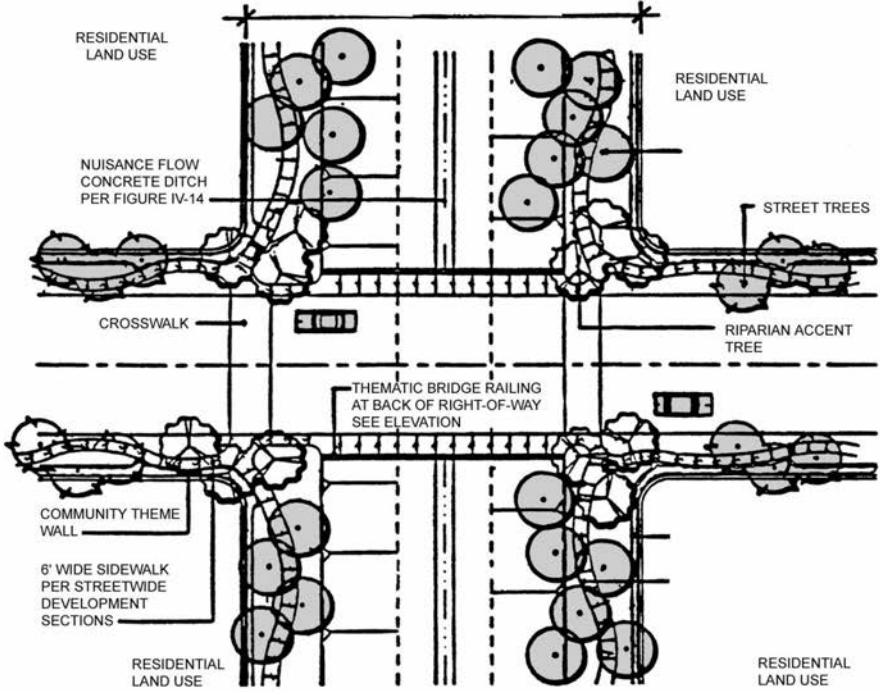

EXAMPLE OF DESIGN ADJACENT TO EASTVALE DRAINAGE PLAN FLOOD CHANNELS.

**COUNTYWIDE
DESIGN GUIDELINES**

COUNTY OF RIVERSIDE

**REVERSE FRONTAGE
TREATMENTS**

Exhibit F

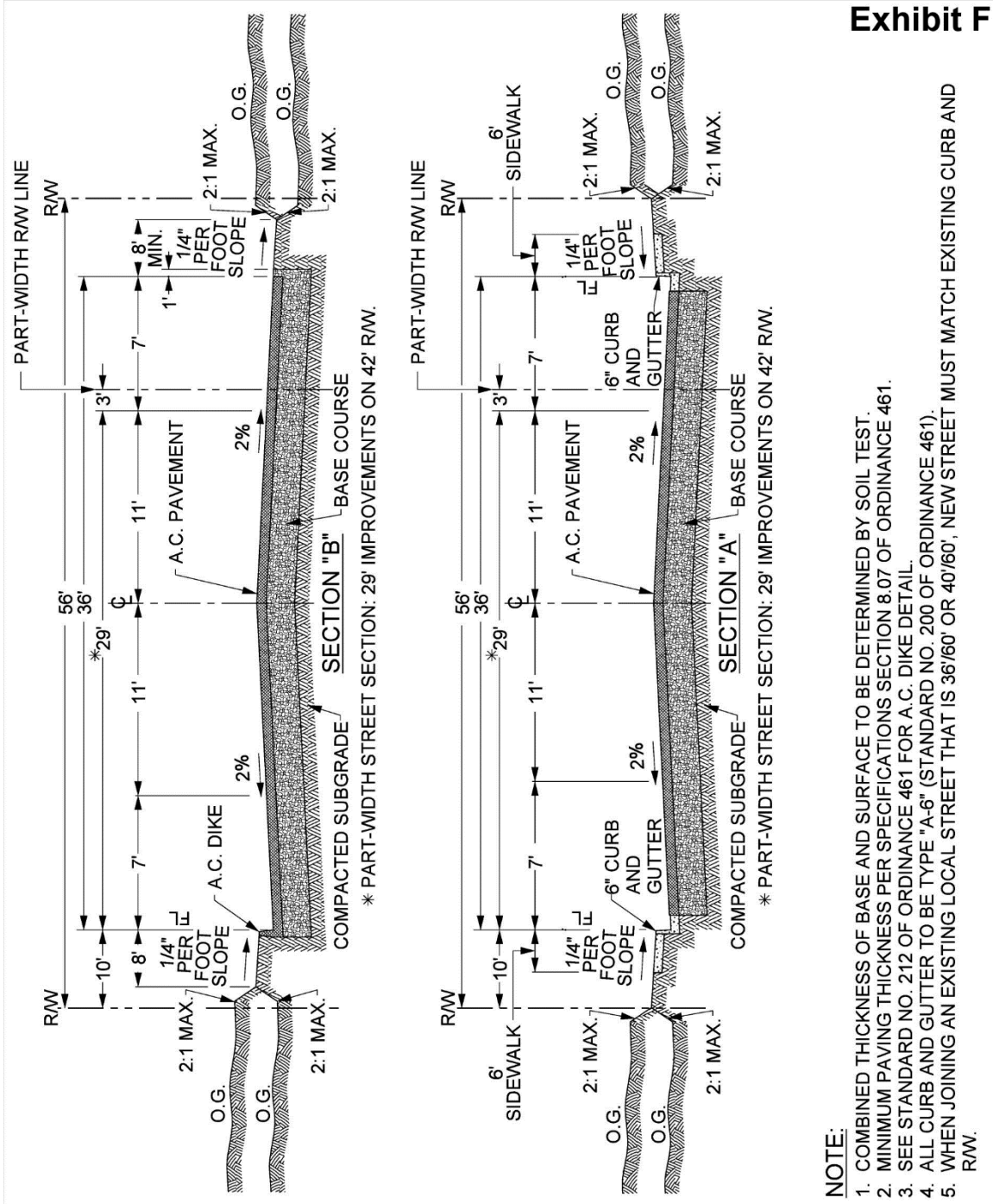

- NOTE:**
1. COMBINED THICKNESS OF BASE AND SURFACE TO BE DETERMINED BY SOIL TEST.
 2. MINIMUM PAVING THICKNESS PER SPECIFICATIONS SECTION 8.07 OF ORDINANCE 461.
 3. SEE STANDARD NO. 212 OF ORDINANCE 461 FOR A.C. DIKE DETAIL.
 4. ALL CURB AND GUTTER TO BE TYPE "A-6" (STANDARD NO. 200 OF ORDINANCE 461).
 5. WHEN JOINING AN EXISTING LOCAL STREET THAT IS 36'/60' OR 40'/60', NEW STREET MUST MATCH EXISTING CURB AND R/W.

**COUNTYWIDE
 DESIGN GUIDELINES**

1-29-04

COUNTY OF RIVERSIDE

LOCAL STREET

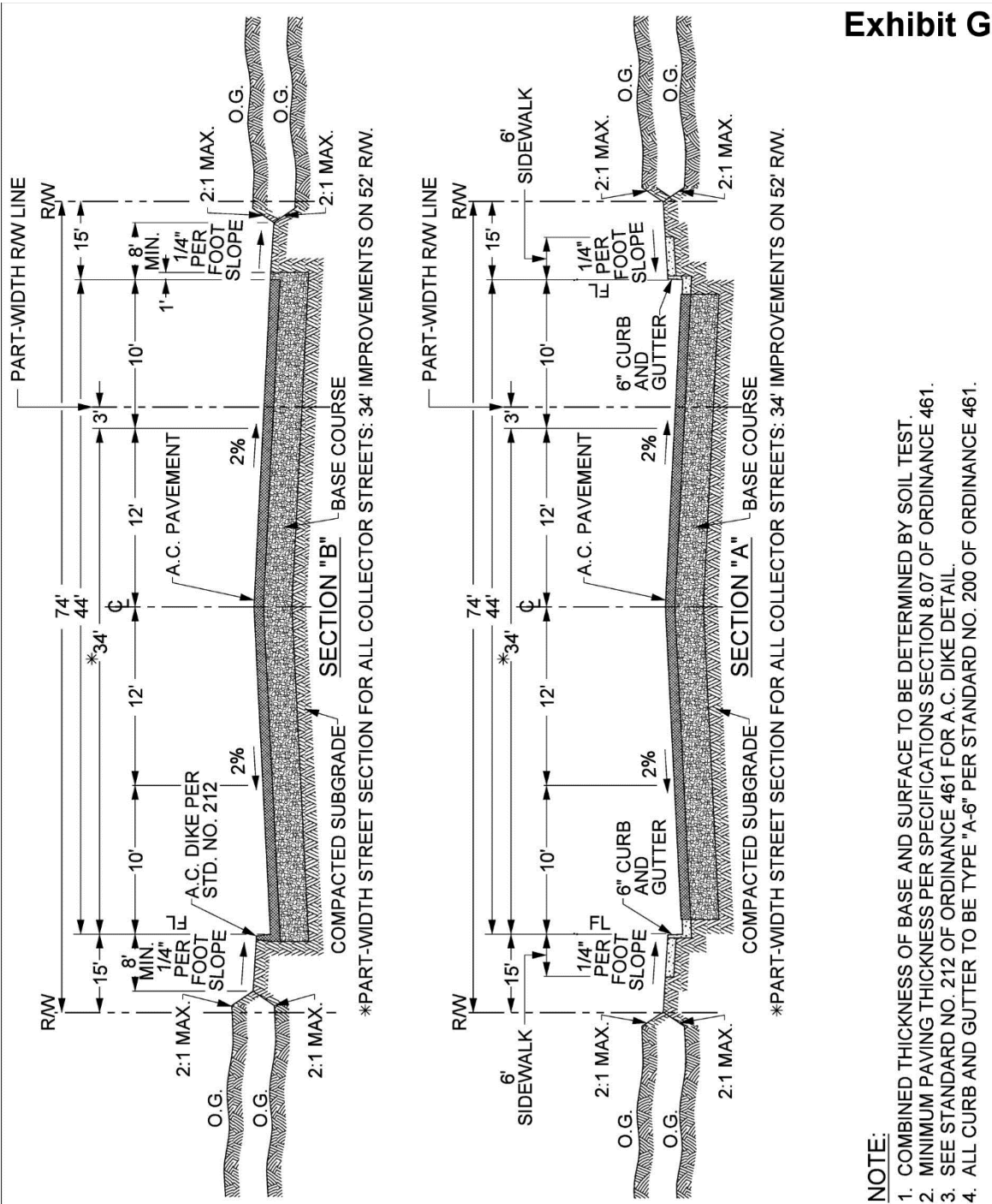

NOTE:

1. COMBINED THICKNESS OF BASE AND SURFACE TO BE DETERMINED BY SOIL TEST.
2. MINIMUM PAVING THICKNESS PER SPECIFICATIONS SECTION 8.07 OF ORDINANCE 461.
3. SEE STANDARD NO. 212 OF ORDINANCE 461 FOR A.C. DIKE DETAIL.
4. ALL CURB AND GUTTER TO BE TYPE "A-6" PER STANDARD NO. 200 OF ORDINANCE 461.

**COUNTYWIDE
DESIGN GUIDELINES**

COUNTY OF RIVERSIDE

COLLECTOR STREET

1-29-04

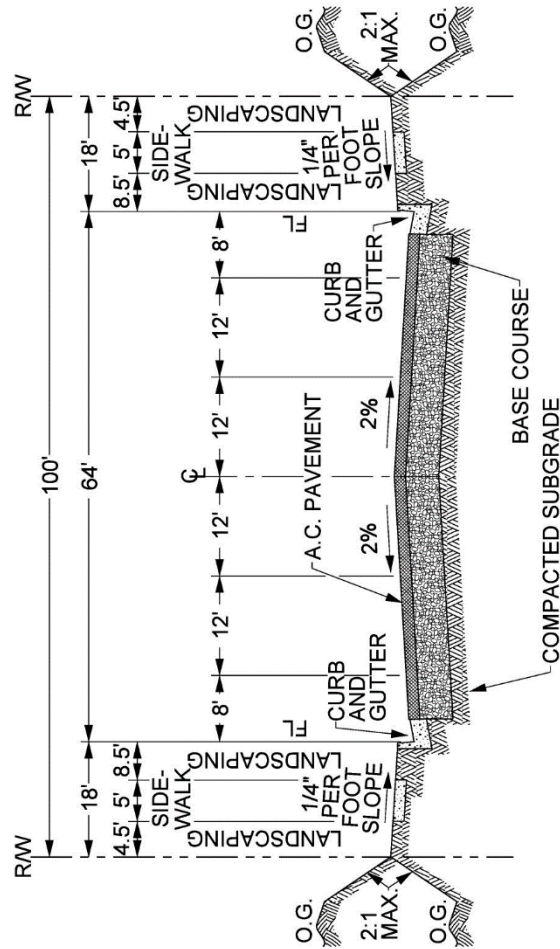

NOTE:
 1. COMBINED THICKNESS OF BASE AND SURFACE TO BE DETERMINED BY SOIL TEST.
 2. MINIMUM PAVING THICKNESS PER SPECIFICATIONS SECTION 8.07 OF ORDINANCE 461.

**COUNTYWIDE
 DESIGN GUIDELINES**

COUNTY OF RIVERSIDE

**SECONDARY
 HIGHWAY**

1-29-04

Exhibit I

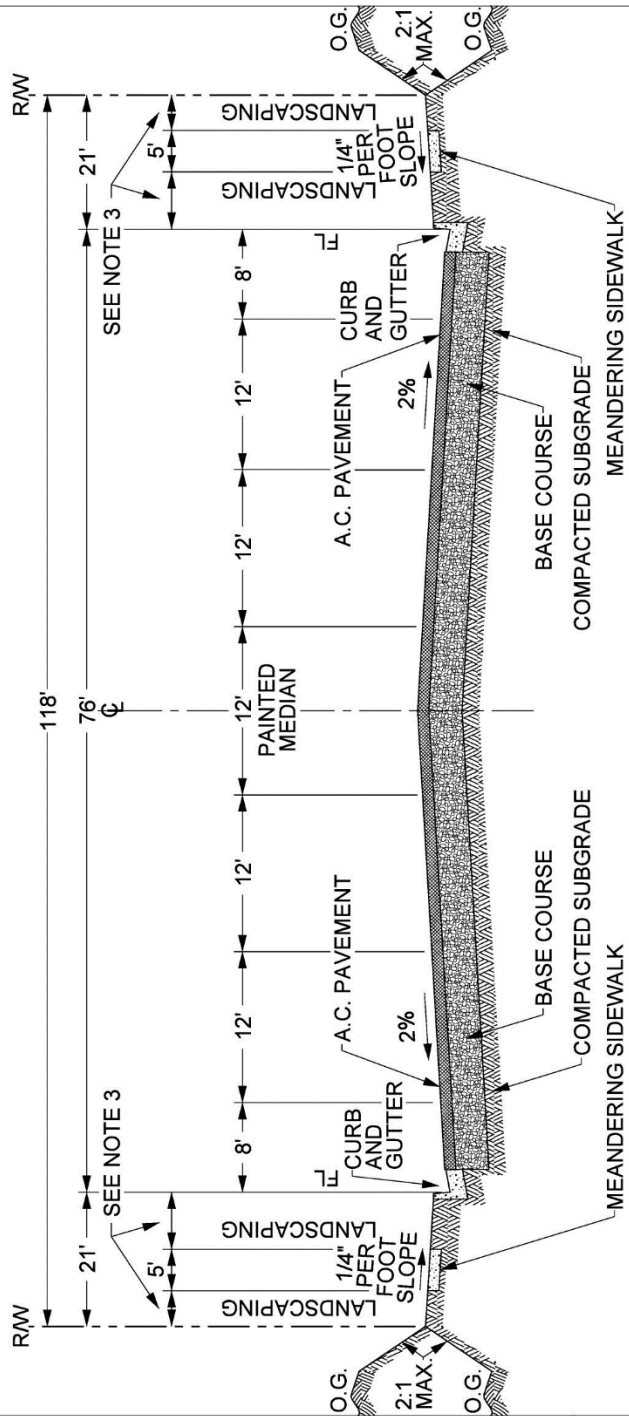

NOTE:
 1. COMBINED THICKNESS OF BASE AND SURFACE TO BE DETERMINED BY SOIL TEST.
 2. MINIMUM PAVING THICKNESS PER SPECIFICATIONS SECTION 8.07 OF ORDINANCE 461.
 3. DISTANCE FROM SIDEWALK TO RW, AND TO FLOW LINE, VARIES. SEE "MEANDERING SIDEWALK" EXHIBIT FOR DETAILS.

COUNTYWIDE DESIGN GUIDELINES

COUNTY OF RIVERSIDE

MAJOR HIGHWAY

1-29-04

Exhibit J

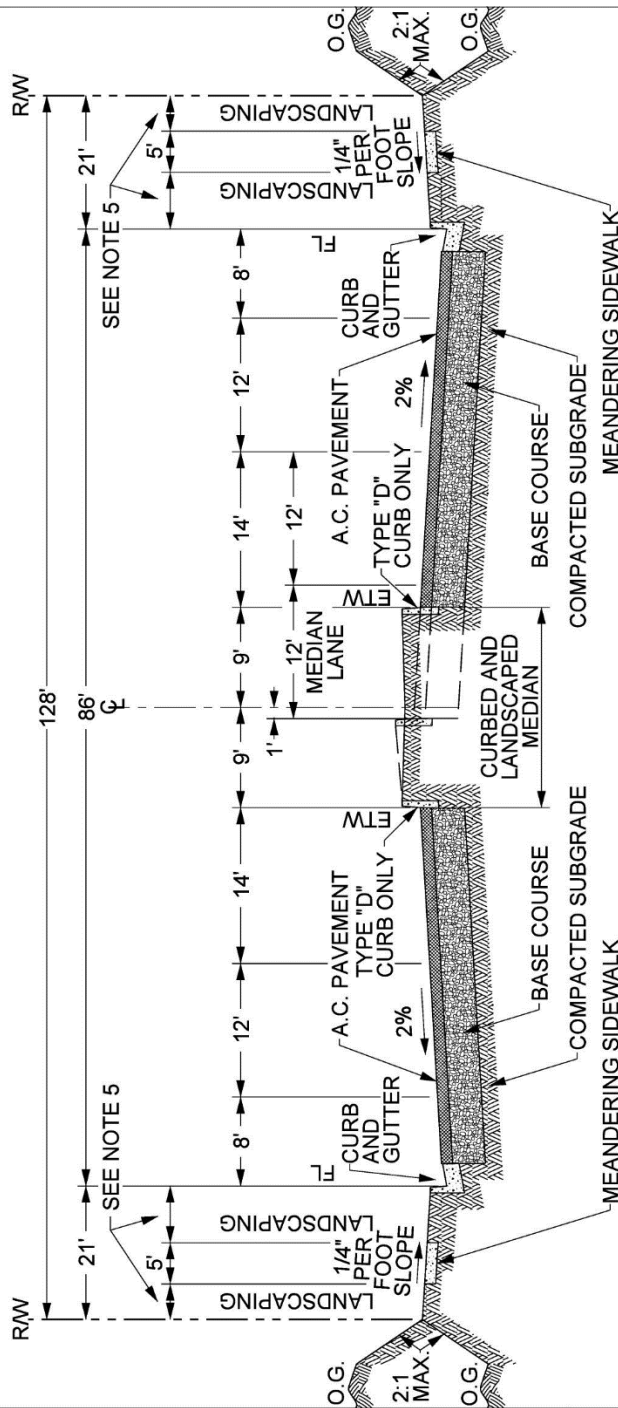

NOTE:

1. COMBINED THICKNESS OF BASE AND SURFACE TO BE DETERMINED BY SOIL TEST.
2. MINIMUM PAVING THICKNESS PER SPECIFICATIONS SECTION 8.07 OF ORDINANCE 461.
3. SEE STANDARD NO. 113 OF ORDINANCE 461 FOR LANDSCAPE MEDIAN REQUIREMENTS, INCLUDING MEDIAN CURB.
4. CURB AND GUTTER TO BE TYPE "A-8" (STANDARD NO. 201 OF ORDINANCE 461).
5. DISTANCE FROM SIDEWALK TO R/W, AND TO FLOW LINE, VARIES. SEE "MEANDERING SIDEWALK" EXHIBIT FOR DETAILS.

COUNTYWIDE DESIGN GUIDELINES

1-29-04

COUNTY OF RIVERSIDE

ARTERIAL HIGHWAY

Exhibit K

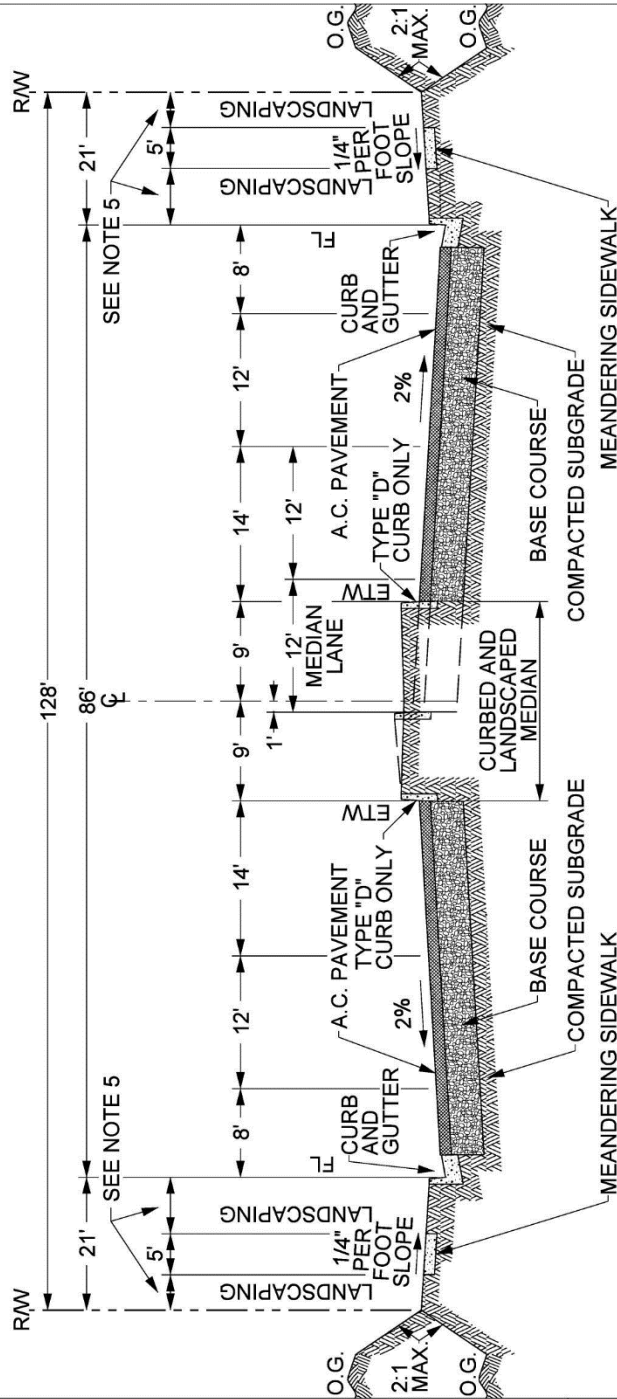

- NOTE:**
1. COMBINED THICKNESS OF BASE AND SURFACE TO BE DETERMINED BY SOIL TEST.
 2. MINIMUM PAVING THICKNESS PER SPECIFICATIONS SECTION 8.07 OF ORDINANCE 461.
 3. SEE STANDARD NO. 113 OF ORDINANCE 461 FOR LANDSCAPE MEDIAN REQUIREMENTS, INCLUDING MEDIAN CURB.
 4. CURB AND GUTTER TO BE TYPE "A-8" (STANDARD NO. 201 OF ORDINANCE 461).
 5. DISTANCE FROM SIDEWALK TO RW, AND TO FLOW LINE, VARIES. SEE "MEANDERING SIDEWALK" EXHIBIT FOR DETAILS.

COUNTYWIDE DESIGN GUIDELINES

COUNTY OF RIVERSIDE

ARTERIAL HIGHWAY

1-29-04

Exhibit L

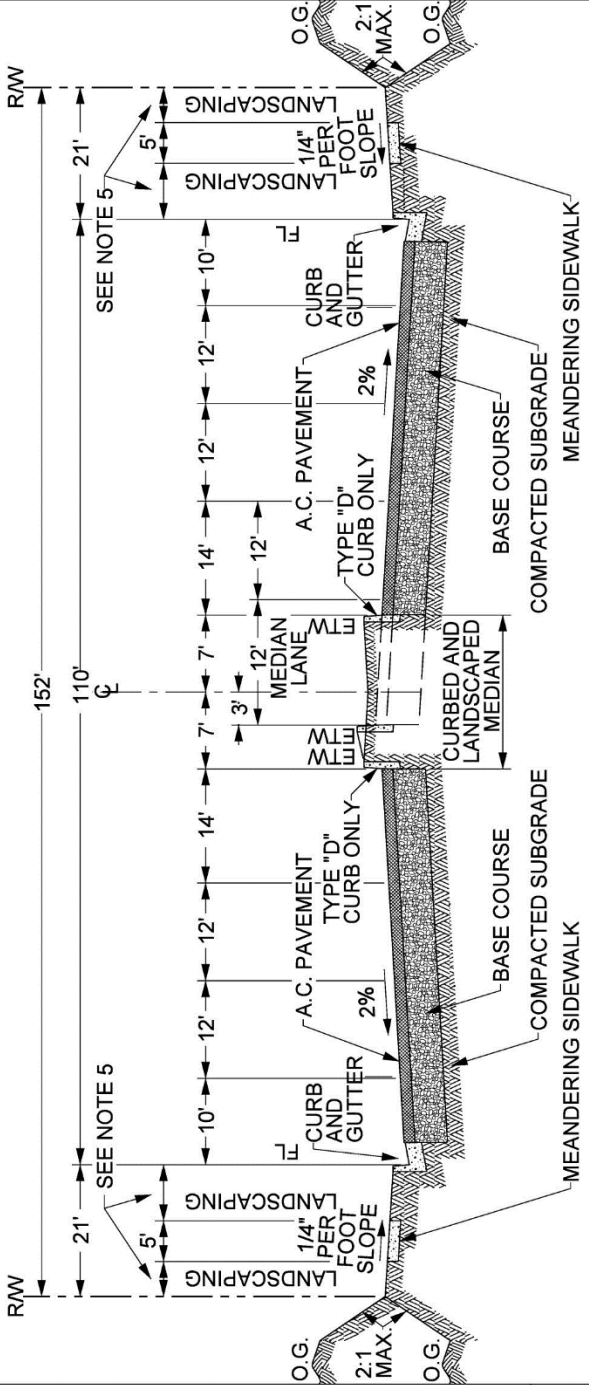

- NOTE:**
1. COMBINED THICKNESS OF BASE AND SURFACE TO BE DETERMINED BY SOIL TEST.
 2. MINIMUM PAVING THICKNESS PER SPECIFICATIONS SECTION 8.07 OF ORDINANCE 461.
 3. SEE STANDARD NO. 113 OF ORDINANCE 461 FOR LANDSCAPE MEDIAN REQUIREMENTS, INCLUDING MEDIAN CURB.
 4. CURB AND GUTTER TO BE TYPE "A-8" (STANDARD NO. 201 OF ORDINANCE 461).
 5. DISTANCE FROM SIDEWALK TO RW, AND TO FLOW LINE, VARIES. SEE "MEANDERING SIDEWALK" EXHIBIT FOR DETAILS.

**COUNTYWIDE
DESIGN GUIDELINES**

COUNTY OF RIVERSIDE
**URBAN ARTERIAL
HIGHWAY**

1-29-04

Exhibit M

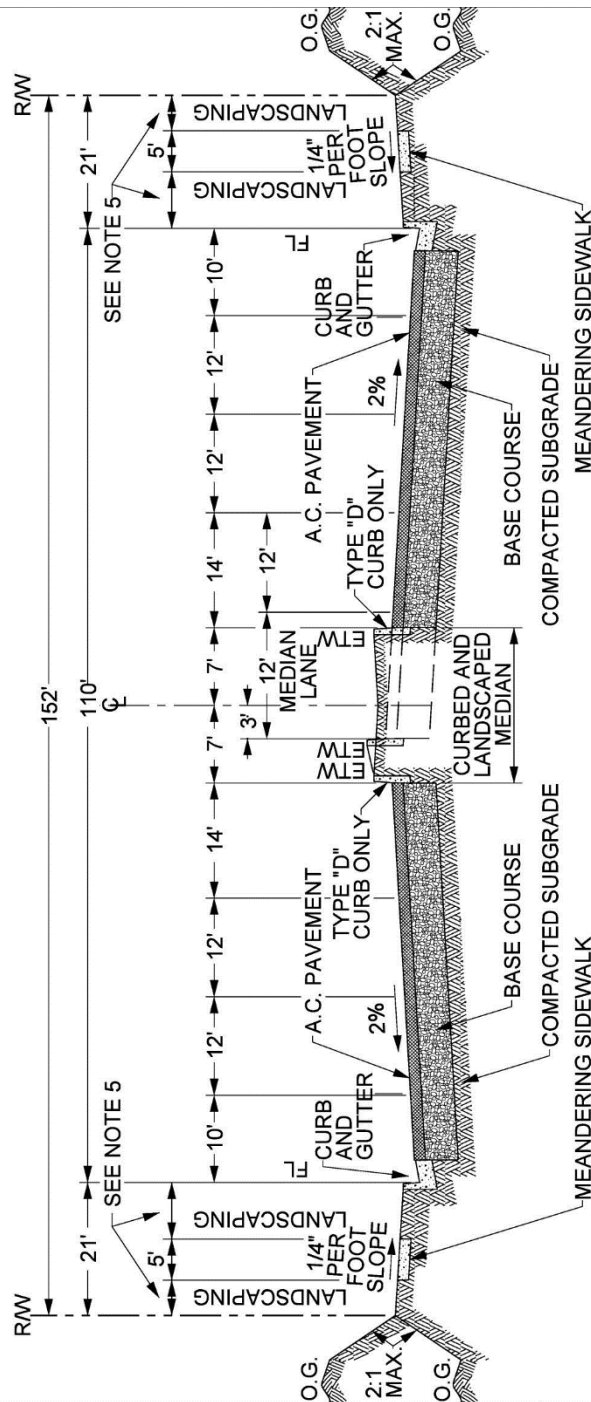

NOTE:

1. COMBINED THICKNESS OF BASE AND SURFACE TO BE DETERMINED BY SOIL TEST.
2. MINIMUM PAVING THICKNESS PER SPECIFICATIONS SECTION 8.07 OF ORDINANCE 461.
3. SEE STANDARD NO. 113 OF ORDINANCE 461 FOR LANDSCAPE MEDIAN REQUIREMENTS, INCLUDING MEDIAN CURB.
4. CURB AND GUTTER TO BE TYPE "A-8" (STANDARD NO. 201 OF ORDINANCE 461).
5. DISTANCE FROM SIDEWALK TO RW, AND TO FLOW LINE, VARIES. SEE "MEANDERING SIDEWALK" EXHIBIT FOR DETAILS.

COUNTYWIDE DESIGN GUIDELINES

1-29-04

COUNTY OF RIVERSIDE

URBAN ARTERIAL HIGHWAY

Exhibit N

NOTES:

1. ALL VINYL FENCING MUST BE COMMERCIAL GRADE.
2. ALUMINUM POST AND ALUMINUM BOTTOM RAILS ARE REQUIRED (NO WOOD OR GALVANIZED MATERIAL).
3. ALL SUBMITTALS REQUIRE PLANS AND CALCULATIONS FOR 101 MPH WIND SPEED. MINIMUM EXPOSURE "C".
4. PLANS AND CALCULATIONS SHALL BE SUBMITTED WITH FENCE AND WALL PLOT PLAN.
5. ALL FENCING INSTALLATIONS WILL REQUIRE CONTRACTOR CERTIFICATIONS.
6. GROUND MOUNT ONLY, NOT TO EXCEED 7 FEET IN HEIGHT.
7. ANY DEVIATIONS FROM THIS STANDARD WILL REQUIRE PLANNING DEPARTMENT APPROVAL AND MAY REQUIRE BUILDING PERMITS.
8. FOOTING DEPTHS SHOULD BE PER TABLE 1 AS SHOWN BELOW.

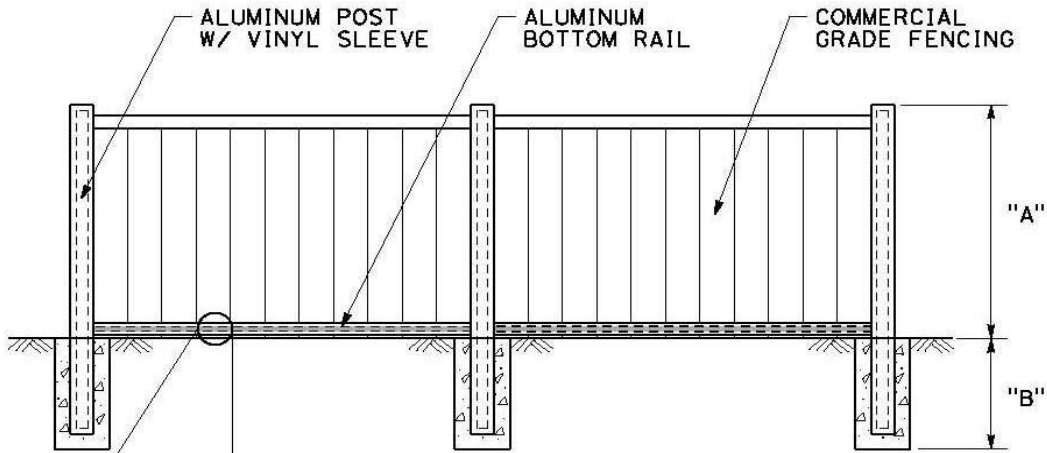
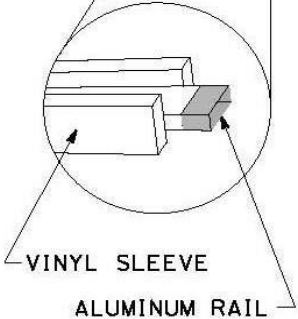

TABLE 1

FENCE HEIGHT	FOOTING DEPTH
"A"	"B"
5'0"	20"
6'0"	24"
7'0"	28"



	COUNTY OF RIVERSIDE PLANNING DEPARTMENT	
	INTERIOR VINYL FENCING FOR TRACT HOMES	
(951) 955-3200	COUNTYWIDE DESIGN GUIDELINES	
FAX: (951) 955-1817	8-20-14	

Exhibit O

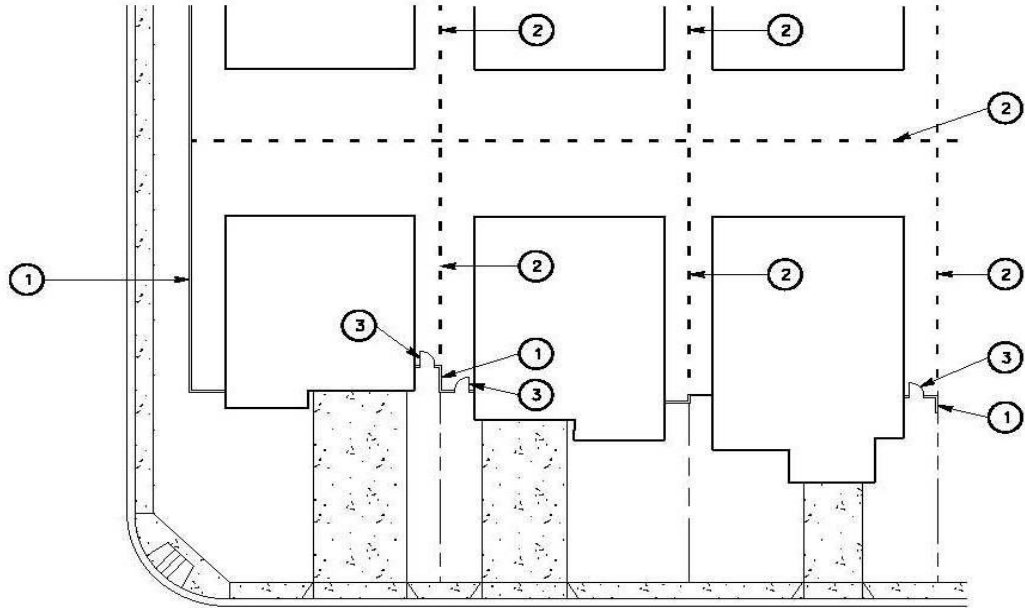

LEGEND:

- (1) DECORATIVE MANSORY BLOCK WALL ALONG PORTIONS VIEWABLE FROM STREET.
- - (2) VINYL FENCING AT REAR AND SIDEYARDS BETWEEN LOTS.
- ∩ (3) 3' WIDE SIDEYARD ACCESS GATE.

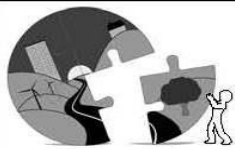
	<p>COUNTY OF RIVERSIDE PLANNING DEPARTMENT</p>	
	<p>INTERIOR VINYL FENCING FOR TRACT HOMES</p>	
<p>(951) 955-3200</p>	<p>COUNTYWIDE DESIGN GUIDELINES</p>	
<p>FAX: (951) 955-1817</p>	<p>8-20-14</p>	

Appendix B

ADDITIONAL PHOTOGRAPHIC EXAMPLES

Building Articulation



Front Porch Treatments



Examples of Landscape Buffers, Mini-Parks, and Paseos



Walls and Fences



Garage Door Treatments

